











acionamento de substituição para 3RT107.-X.-0LA2 ou 3RT147.-X.-0LA2 110 V CC x (0,7-1,25) tensão de alimentação entrada de CLP 24...110V CC conexão de mola

nome da marca do produto	SIRIUS
categoria do produto	Bobinas magnéticas
designação do produto	Acionamento de substituição
designação do tipo de produto	3RT19

Dados técnicos gerais	
Diretiva RSP (Data)	09/06/2016
SVHC substance name	Lead CAS-No. 7439-92-1 Lead monoxide (lead oxide) CAS-No. 1317-36-8 2,2',6,6'-tetrabromo-4,4'-isopropylidenediphenol CAS-No. 79-94-7 2-methyl-1-(4-methylthiophenyl)-2-morpholinopropan-1-one CAS-No. 71868-10-5 Melamine CAS-No. 108-78-1
Peso líquido por ME	1,289 kg

Homologações certificados

Environment	General Product Approval	EMV	Test Certificates
Environmental Confirmations	 EG-Konf.	 UL	  RCM
			Type Test Certificates/Test Report

Test Certificates	Maritime application	other
Special Test Certificate	 ABS	 DNV
	 PRS	 产品合格 QC PASS
		Confirmation

other	Railway
Miscellaneous	Special Test Certificate

Outras informações

Informações sobre a embalagem
[Informações sobre a embalagem](#)
 Information for data generation and storage
<https://support.industry.siemens.com/cs/ww/en/view/109995012>
 Information- and Downloadcenter (catálogo, brochuras,...)
<https://www.siemens.com/ic10>

Industry Mall (encomendar online)

<https://mall.industry.siemens.com/mall/pt/pt/Catalog/product?mlfb=3RT1975-5XF42>

CAX Online Generator

<https://support.automation.siemens.com/WW/CAXorder/default.aspx?lang=en&mlfb=3RT1975-5XF42>

Service&Support (manuais, manuais de instruções, certificados, curva característica, FAQs,...)

<https://support.industry.siemens.com/cs/ww/en/ps/3RT1975-5XF42>

Base de dados das imagens (fotografias do produto, desenhos de medida em 2D, modelos em 3D, esquemas eléctricos, macros EPLAN...)

https://www.automation.siemens.com/bilddb/cax_de.aspx?mlfb=3RT1975-5XF42&lang=en

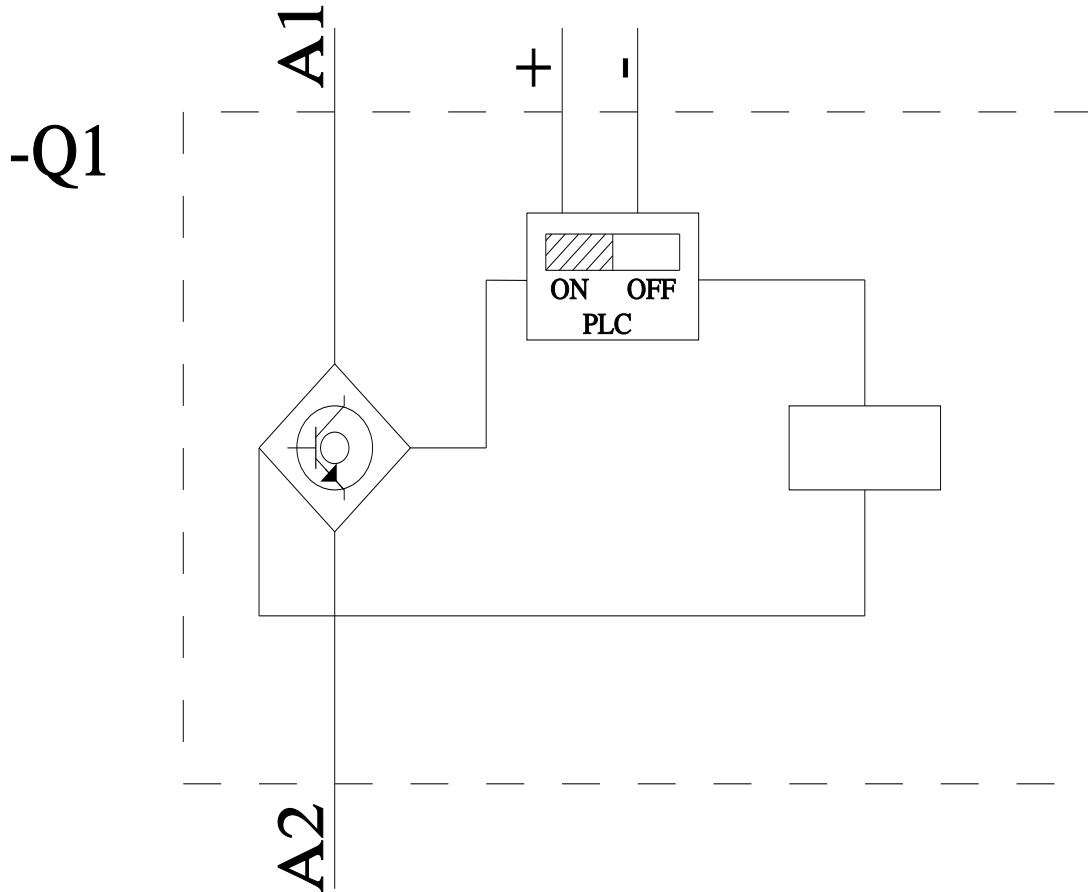

última alteração:

17/10/2025 